

Article number: 20193V40V40602BL
 Description: E+G T-angel clamp
 GN 193-V40-V40-60-2-BL

Measures

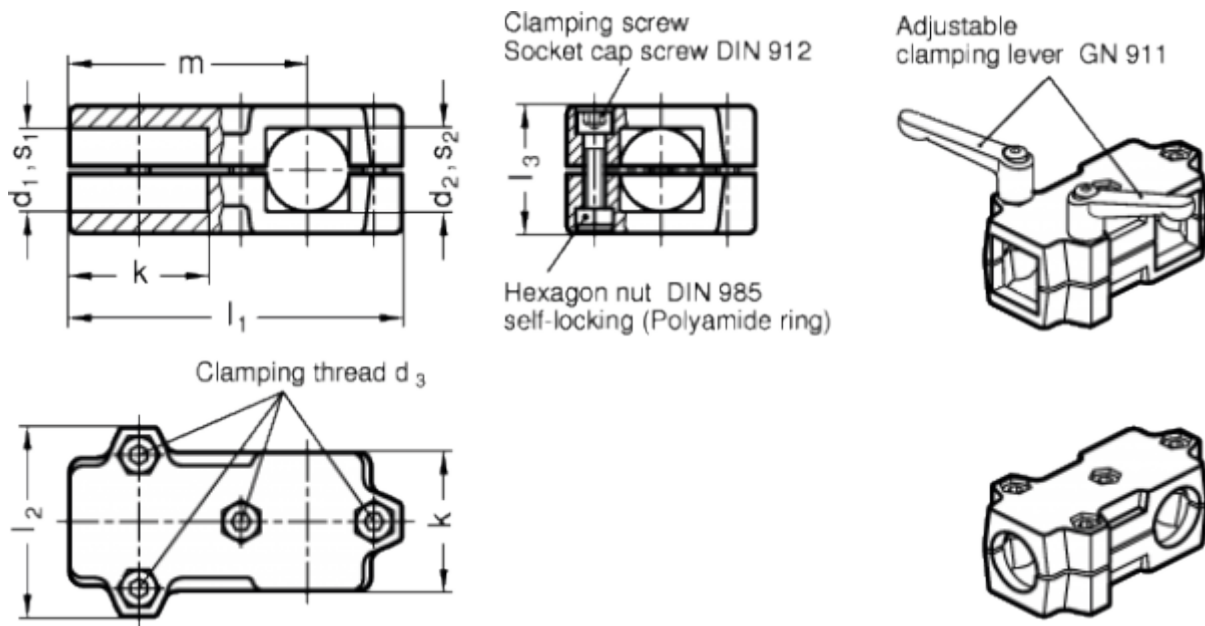

Accessories = GN 911-M8-55	m	= -
d1 = -	s1	= 40
d2 = -	s2	= 40
d3 = M8	Weight in (g)	= 638
k = 60		
l1 = 141		
l2 = 79		
l3 = 59		